

Addition of decimals

- 1 $1511.67 + 113 + 2680.3 + 2109 + 4.306 =$
- 2 $5378.072 + 229.3 + 907.07 + 1460 + 7.47 =$
- 3 $2145.66 + 838.5 + 6950.123 + 896 + 4.48 =$
- 4 $7592.614 + 596.2 + 4690.6 + 2413 + 7.736 =$
- 5 $7559.151 + 983.5 + 6171.931 + 430 + 7.08 =$
- 6 $4080.004 + 876 + 2103.7 + 106 + 6.742 =$
- 7 $401.164 + 641.7 + 6863.7 + 939 + 3.34 =$
- 8 $7441.526 + 617.3 + 4896.1 + 3529 + 3.546 =$
- 9 $5754.07 + 148.7 + 7964.1 + 471 + 7.478 =$
- 10 $5032.819 + 160.7 + 3269.3 + 337 + 0.62 =$

11. Look at the shapes below. Calculate their perimeter (the distance round the edge).

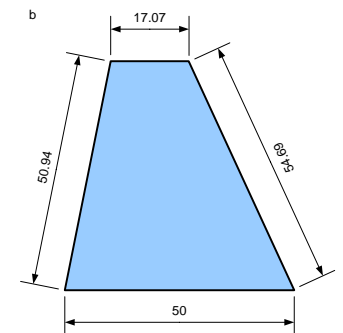
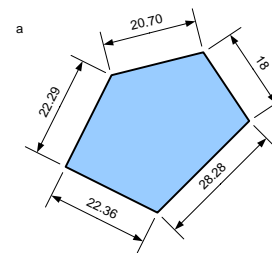

All dimensions are shown in mm.

[DECIMAL CALCULATIONS]

Addition, subtraction, division and multiplication of decimals as well as ordering and placing them on a number line are included in this booklet.

12. Below is a price list for a clothes shop. Ethan decided to spend his birthday money on some clothes.

Price List		
Blue shirt	...	£27.84
Red shirt	...	£28.40
Green shirt	...	£17.28
White shirt	...	£14.99
Red striped shirt	...	£31.88
Blue striped shirt	...	£32.73
Grey trousers	...	£49.95
Green trousers	...	£47.57
Blue trousers	...	£49.50
Denim jeans	...	£34.96
Denim jean skirt	...	£38.99

- How much does it cost for a blue shirt, some grey trousers and a pair of jeans?
- How much does it cost for a red shirt, a red striped shirt and a pair of blue trousers?
- How much does it cost for a red striped shirt, a blue striped shirt, a green shirt and a pair of grey trousers?
- How much does it cost for a pair of grey trousers, a pair of green trousers and a pair of denim jeans?
- How much does it cost for one shirt of each design?
- How much does it cost for three of the cheapest pairs of trousers? (each one being different).

Subtraction of decimals

- $371.4 - 4.958 =$
- $361.45 - 2.686 =$
- $810.11 - 3.906 =$
- $7769.8 - 4.594 =$
- $671.3 - 0.274 =$
- $96.28 - 3.176 =$
- $76.24 - 2.92 =$
- $1494.7 - 3.04 =$
- $55.39 - 5.432 =$
- $4506.806 - 7.372 =$

11. Work out the lengths of the missing sides on the shapes below. All dimensions are given in mm.

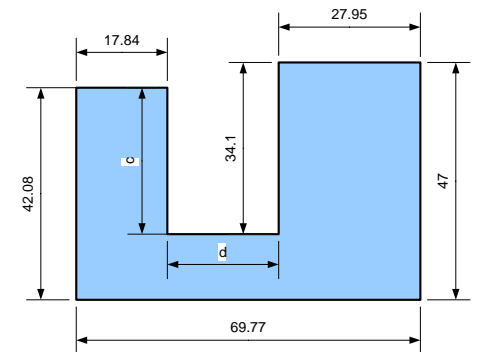
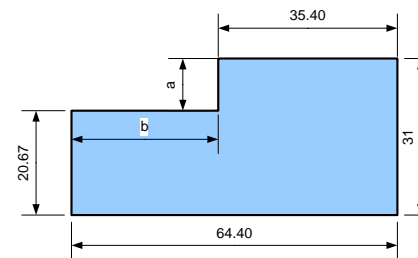

12. Calculate the perimeter of the shape below. You will need to add and subtract decimals to be able to do this.

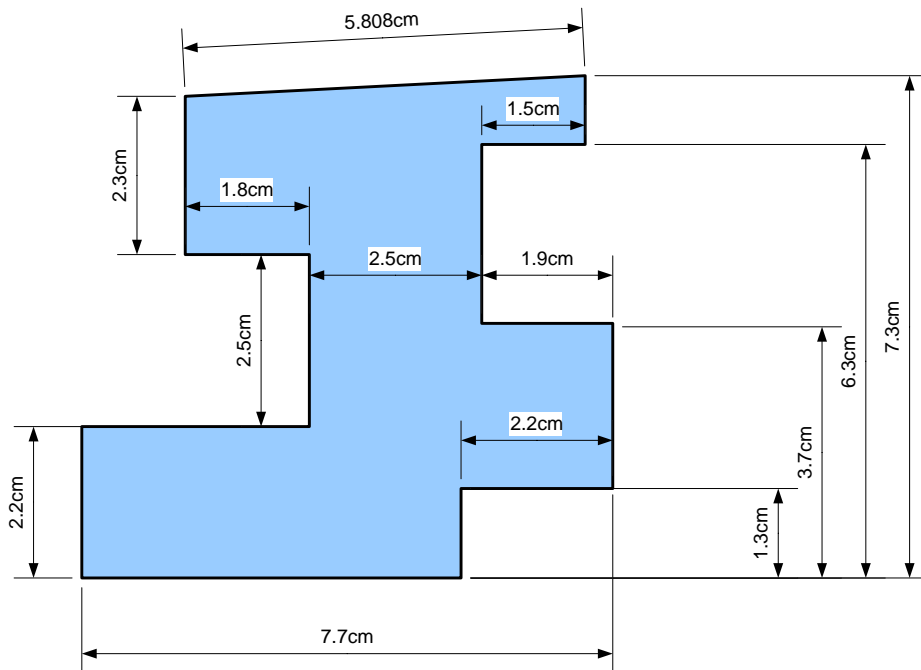

Hints: Draw a diagram in your book.

Mark onto each side, its length in cm. (You will need to do some subtraction here).

Check you have all the lengths marked on your diagram.

Add together all the lengths.

Price List

Blue shirt	...	£27.84
Red shirt	...	£28.40
Green shirt	...	£17.28
White shirt	...	£14.99
Red striped shirt	...	£31.88
Blue striped shirt	...	£32.73
Grey trousers	...	£49.95
Green trousers	...	£47.57
Blue trousers	...	£49.50
Denim jeans	...	£34.96
Denim jean skirt	...	£38.99

13. a. What is the difference in price between the cheapest and most expensive item?
- b. Ethan buys his sister a denim skirt. He hands over £40 to pay for it. How much change does he receive?
- c. For school, Ethan needs some grey trousers and a white shirt. He hands four twenty pound notes to the shop assistant. How much change should he get?
- d. Emily buys Ethan a birthday present. She buys him a pair of denim jeans. How much change does she get from £40?
- e. Ethan bought two of each striped shirt. He paid with seven twenty pound notes. How much change did he get?
- f. Ethan bought himself three pairs of trousers: a grey pair, a green pair and a blue pair. How much change did he get from eight twenty pound notes?

Multiplication of decimals

- 1 $846.7 \times 3.062 =$
- 2 $927.75 \times 4.15 =$
- 3 $178.05 \times 4.464 =$
- 4 $3801.3 \times 0.028 =$
- 5 $240.3 \times 2.09 =$
- 6 $138.54 \times 7.608 =$
- 7 $86.704 \times 0.304 =$
- 8 $9539 \times 6.898 =$
- 9 $378.95 \times 5.626 =$
- 10 $2438.896 \times 3.19 =$

11. What is the area of the following shapes (dimensions given in m)?

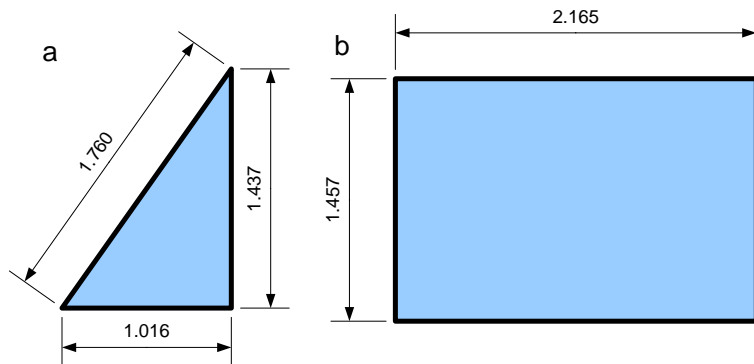

12. What is the area of the following shape? All dimensions are given in metres.

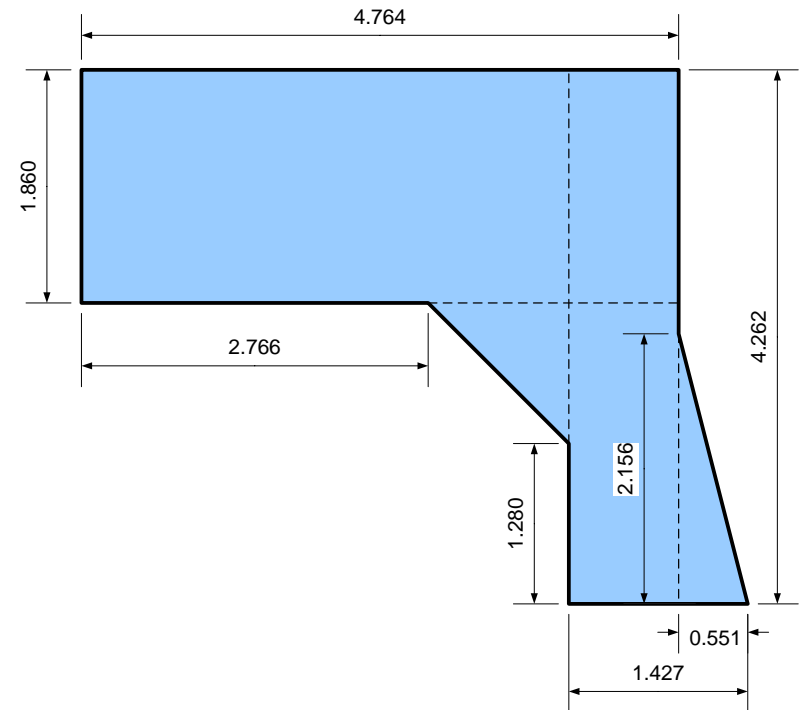

Hint: I have already divided up the shape into five sections for you.

Letter each part of the shape and then specify how you are going to calculate the area of that part.

The triangle near the centre is harder to see what you need to do than the other shapes. As a clue to work out the height of the triangle, you will need the numbers 1.280, 4.262 and 1.860. You will need to add and take away these numbers to find the gap which forms the height of the triangle. You will have a similar operation to perform with the length.

Price List

Blue shirt	...	£27.84
Red shirt	...	£28.40
Green shirt	...	£17.28
White shirt	...	£14.99
Red striped shirt	...	£31.88
Blue striped shirt	...	£32.73
Grey trousers	...	£49.95
Green trousers	...	£47.57
Blue trousers	...	£49.50
Denim jeans	...	£34.96
Denim jean skirt	...	£38.99

13. a. How much do six denim skirts cost?
- b. How much do five pairs of grey trousers and two pairs of green trousers cost?
- c. How much change would you get from £300 if you purchased six pairs of denim jeans?
- d. How much change would you get if you purchased three red shirts and two blue striped shirts from £350?
- e. How much more do six pairs of green trousers cost than 5 pairs of grey ones?
- f. How much more do seven pairs of blue trousers and three red striped shirts cost than five pairs of denim jeans and two green shirts?
- g. Ethan decided to open a shop. He negotiated buying 5 of each item and having a sixth thrown in for free. How much money did Ethan spend on stocking up his shop?

Division of decimals

1	4	$\overline{)1425.012}$	6	6	$\overline{)1985.735}$
2	7	$\overline{)433.843}$	7	9	$\overline{)1658.887}$
3	7	$\overline{)876.237}$	8	6	$\overline{)940.89}$
4	8	$\overline{)164.821}$	9	9	$\overline{)725.052}$
5	6	$\overline{)539.259}$	10	8	$\overline{)864.955}$

If the divisor is a decimal, such as 1.6, we cannot do this and so we have to multiply **both the divisor and the dividend** by a multiple of 10 (either 10, 100, 1000, 10000 etc) in order to make the divisor into a whole number (or integer). Then we do the calculation as normal.

11	2.4	$\overline{)133.933}$	16	0.38	$\overline{)2974.335}$
12	2.2	$\overline{)1847.613}$	17	0.25	$\overline{)2388.893}$
13	2.3	$\overline{)2807.265}$	18	0.28	$\overline{)812.46}$
14	2.5	$\overline{)1948.97}$	19	0.5	$\overline{)1394.77}$
15	2.6	$\overline{)1631.411}$	20	0.29	$\overline{)1481.49}$

When you have calculated the answers to these questions, use a calculator to check that you have got them correct.

$$\begin{array}{r}
 1 \\
 6 \overline{) 689421} \\
 \underline{6} \\
 08 \\
 \underline{06} \\
 29 \\
 \underline{24} \\
 54 \\
 \underline{54} \\
 02 \\
 \underline{0} \\
 24 \\
 \underline{24} \\
 0
 \end{array}$$

1. Six divided by six is one. We write that at the top above the six.

2. We now want to find out if there is a remainder. We do this by multiplying six by the one.

3. The third stage is to subtract the six from the six in the way we normally do column subtraction.

4. We bring down the eight in order to allow us to start again with eight divided by six.

This number is called the **divisor**.

The answer which goes at the top is the **quotient**.

This number is the **Dividend**.

When we are dividing one number by another, there are three words to remember. The number being split up is called the **dividend**. The number of parts it is being split into is called the **divisor**. The answer is called the **quotient**.

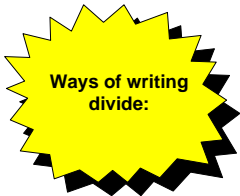
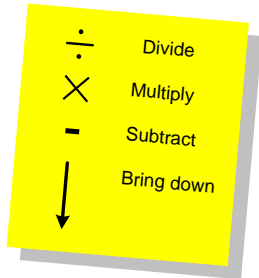

$$\begin{array}{l}
 237 \div 16 \qquad \frac{237}{16} \\
 16 \overline{) 237}
 \end{array}$$



Ordering decimals and fractions and percentages



Place on the grid above: $\frac{1}{2}$, $\frac{3}{4}$, $\frac{3}{8}$, $\frac{1}{4}$, $\frac{9}{16}$

Place on the grid below, 0.5, 0.75, 0.375, 0.25, 0.5625



Put the following into the correct order beginning with the lowest and working up.

- $\frac{1}{2}$
- 0.87
- $\frac{9}{16}$
- 29%
- $\frac{1}{20}$
- $\frac{3}{4}$
- $\frac{5}{8}$
- 124%
- 0.23
- 56%
- $\frac{12}{20}$
- 14%
- $\frac{1}{5}$
- 0.27
- 0.1
- $\frac{3}{20}$
- 0.0956
- 67%

Hint: Start with the percentages, then do the decimal fractions. Once you have done this, move onto the vulgar fractions and you might find it easier to convert these into decimal fractions to help.